

# Waffen, Munition, Optik



# Sicherheit gilt bei allen Waffen als oberste Priorität



# Eidgenössisches Jagdgesetz, Waffenzubehör und Munition

## Das eidgenössische Jagdgesetz

regelt insbesondere :  
Verwendung von Jagdwaffen  
Waffenzubehör  
Verbotene Hilfsmittel  
Fallen für die Jagd



Die kantonale Gesetzgebung kann diese Reglementierung erweitern bzw. einschränken



# Waffenerwerb

## Verbotene Waffen



## Bewilligungspflichtige Waffen



## Meldepflichtige Waffen

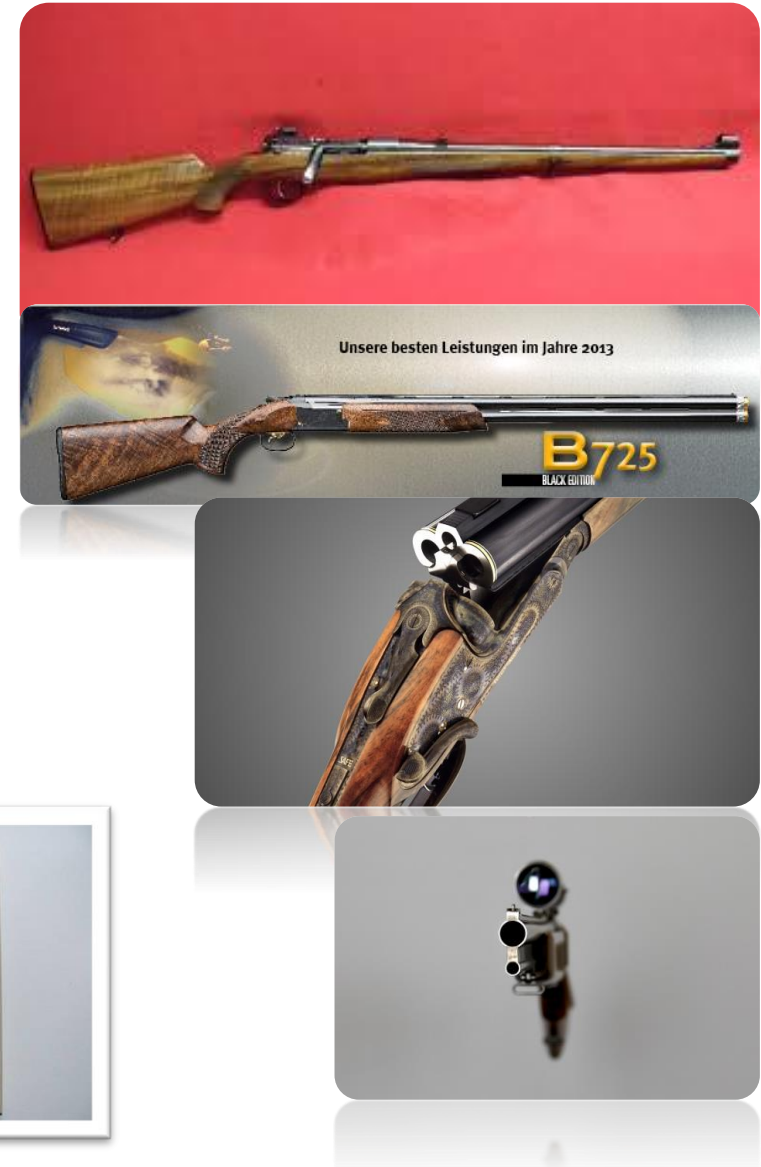

# Die Jägerschaft betreffen insbesondere die meldepflichtigen Waffen

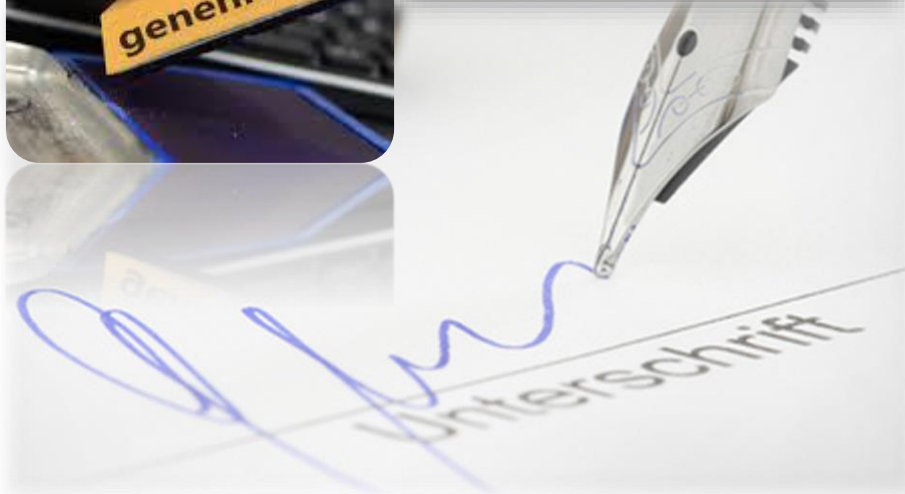

Kauf  
Tausch  
Miete

Ausleihen  
Schenkung  
Erbschaft



Schweizerische Eidgenossenschaft  
Confédération suisse  
Confederazione Svizzera  
Confederaziun svizra

Bundesamt für Justiz BJ  
Office fédéral de la justice OFJ  
Ufficio federale di giustizia UFG  
Federal Office of Justice FOJ  
Oficina federal de justicia OFJ

www.strafregister.admin.ch  
www.casier.admin.ch  
www.casellario.admin.ch  
www.records.admin.ch

3003 Bern, 17.08.2009  
Ref: 2543741

Digitally signed by Roger Dolder, Head of Criminal Records 1  
Time: provided by TSA  
For the integrity and the origin of this document  
Bern, Switzerland  
Swiss Federal Office of Justice,  
strafregister@bj.admin.ch

Auszug aus dem Schweizerischen Strafregister  
Extrait du casier judiciaire suisse  
Estratto del casellario giudiziale svizzero  
Excerpt from the swiss criminal record  
Extracto del registro suizo de antecedentes penales

Test Muster  
Bundesrain 20  
3003 Bern

Geburtsdatum Date de naissance Data di nascita Date of birth Fecha de nacimiento	Heimatort bzw. -staat Lieu resp. pays d'origine Luogo risp. paese d'origine Native place resp. country Pays resp. lugar de origen
19.12.1950	Bern BE CH

ist im Strafregister nicht verzeichnet  
ne figure pas au casier judiciaire  
non figura nel casellario giudiziale  
is not registered in the criminal record  
carece de antecedentes en el registro de antecedentes penales

Strafregister  
Casier judiciaire  
Casellario giudiziale  
Criminal records  
Registro de antecedentes penales

Dieses elektronische Dokument ist nur in elektronischer Form gültig und überprüfbar. Folgende beachten! / Ce document électronique n'est que valide et vérifiable en forme électronique. Voir page successive! / Questo documento elettronico è valido e può essere verificato solamente in forma elettronica. Vedi pagina successiva! / This electronic document is valid and can be verified only in electronic form. See following page! / Este documento electrónico es válido y puede solamente estar verificado en forma electrónica. Seguir página seguida!

ID: 2543741 17.08.2009 / 11:14:02

Mindestalter 18 Jahre



# Aufbewahrung von Waffen

Jeder Waffenbesitzer ist rechtlich verpflichtet, Waffen und Munition korrekt und getrennt aufzubewahren und vor dem Zugriff Dritter zu schützen.

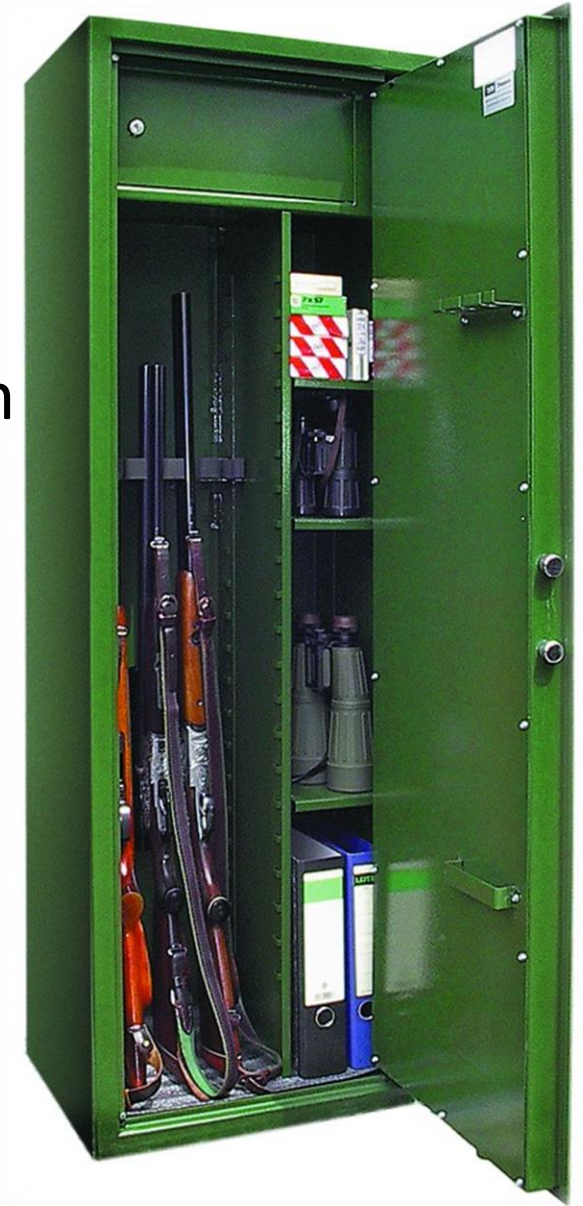

Jeder Verlust ist unverzüglich der Polizei zu melden

# Waffentragbewilligung



Hin- und Rückfahrt  
Jagdgebiet  
Schiessstand  
Waffengeschäft  
Immer auf direktestem Weg

Die Waffe darf nur während des direkten Einsatzes geladen sein und ist unter Verschluss zu transportieren



# Das Einschieszen von Jagdwaffen ausserhalb bewilligter Schiessstände ist verboten





# Transport von Waffen ins Ausland



Personen, die ihre Waffe ins Ausland mitnehmen möchten, müssen die geltenden waffenrechtlichen Bestimmungen des betreffenden Landes beachten.



# Jagdwaffen

Kugelgewehr



Schrotgewehr



Kurz- oder Faustfeuerwaffe



Blanke Waffe



# Langwaffen werden wie folgt unterteilt



Kugelgewehr (Büchse)



Schrotgewehr (Flinte)



Kombinierte Gewehre mit Schrot- und Kugelläufen



# Bestandteile einer Büchse



Schaft aus Kunststoff



Schaft aus Holz



# Bestandteile einer Flinte



Glatter Lauf = Flinte

Gezogener Lauf = Büchse

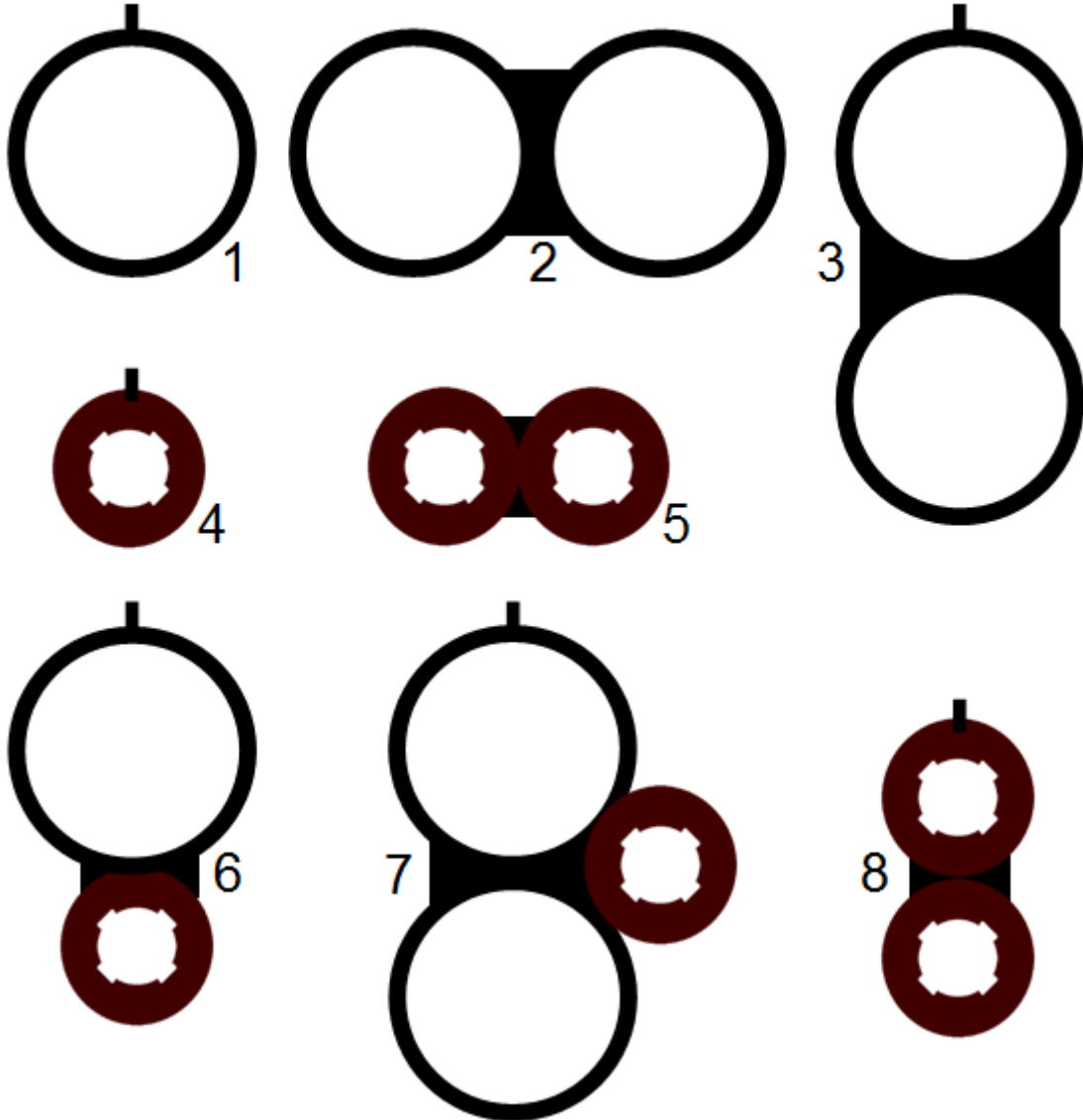

Verschluss



# Kombinierte Waffen

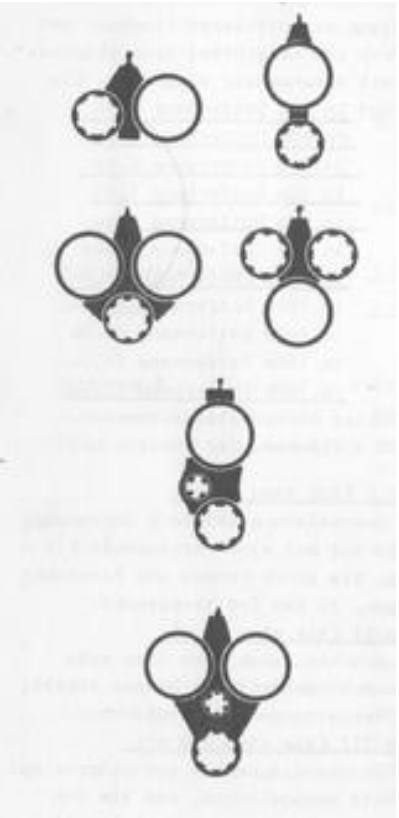

# Patronenlager

Patronenlager Büchse

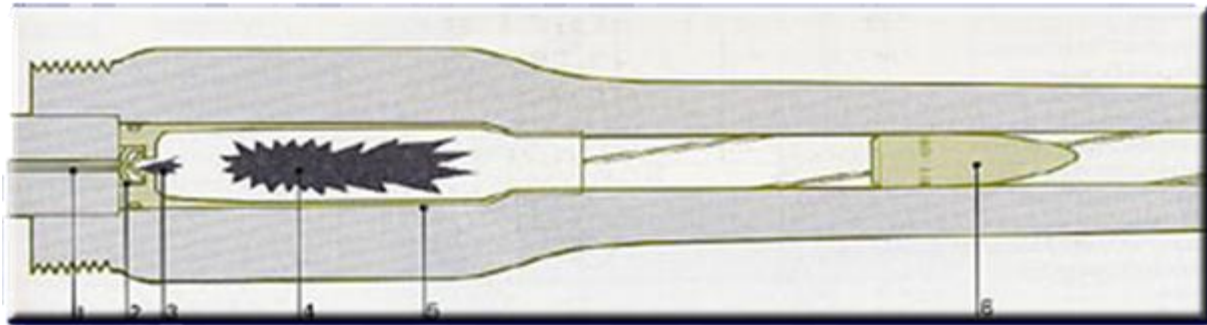

Patronenlager Flinte

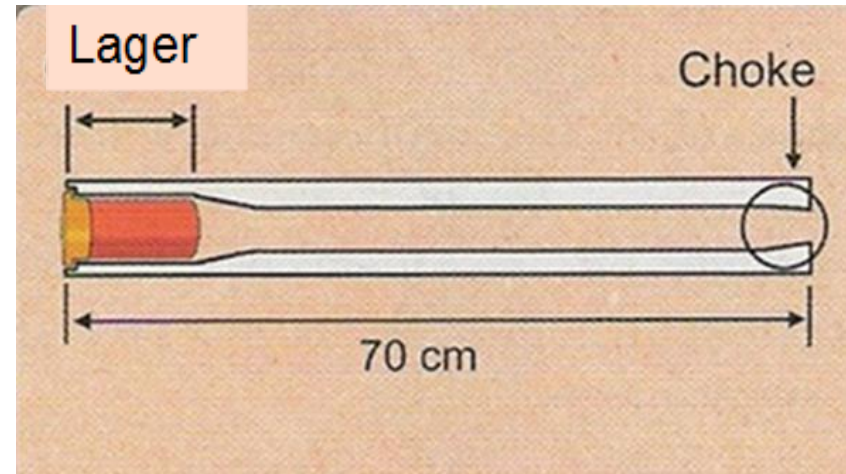

Würgebohrung auch Choke genannt befindet sich an der Laufmündung  
z.B. Vollchoke = grösste mögliche Laufverengung

Auf der Aussenseite des Patronenlagers ist das zu verwendende Kaliber eingraviert.



# Abzüge

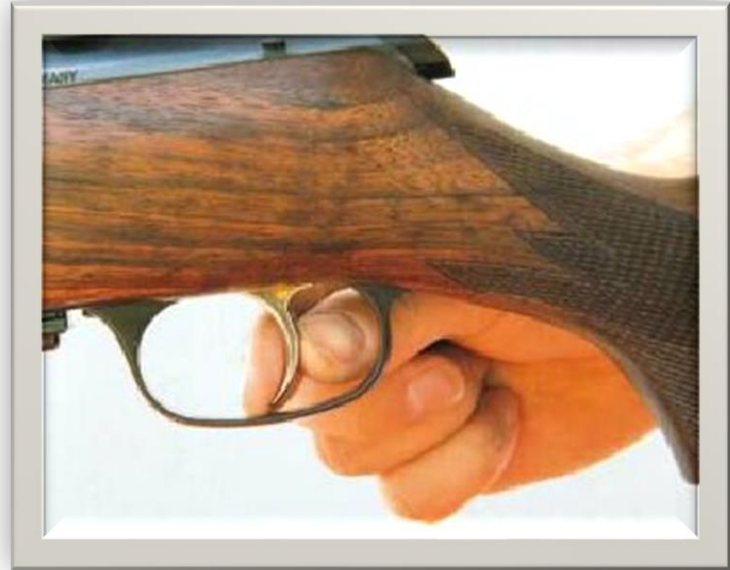
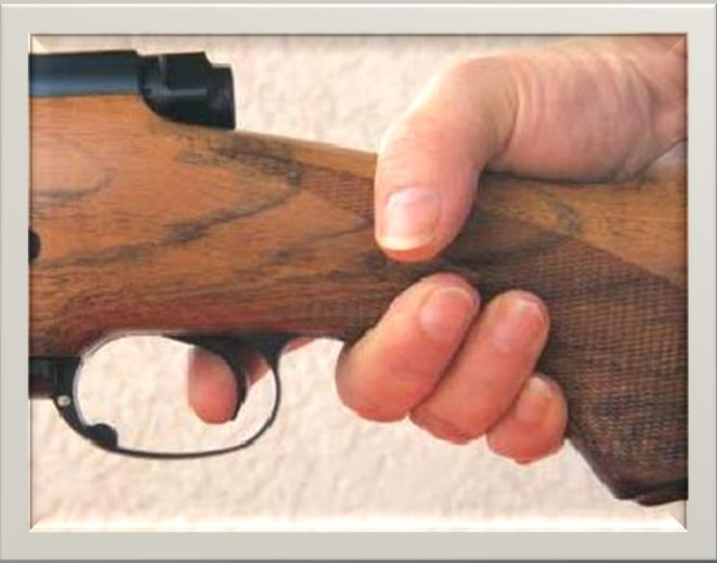

# Sicherung

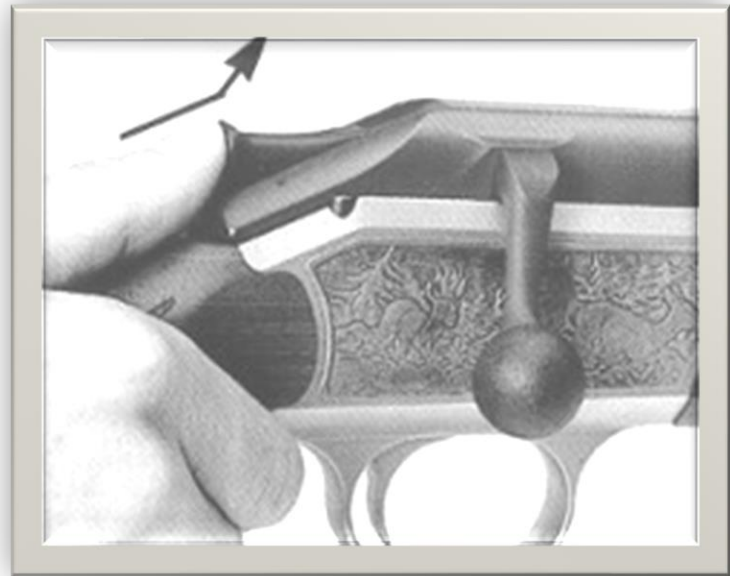
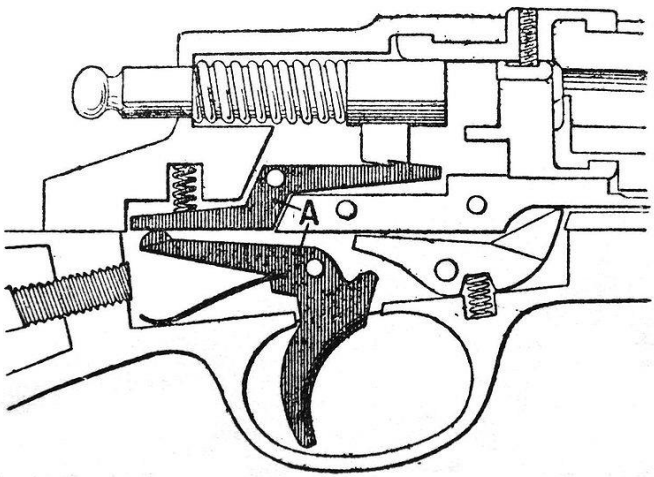

Pistolen  
Revolver  
Fangschussgeber  
Blanke Waffen



# Büchsenmunition

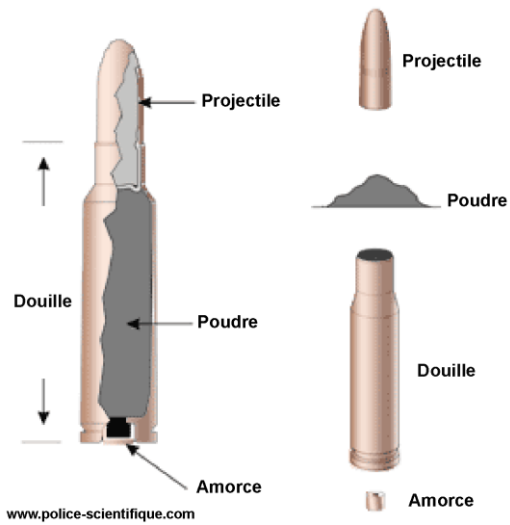

1 grain = 0,065 Gramm  
 140 grain = 9,1 Gramm  
 9,1 Gramm : 0,065 Gramm = 140 grain

Zerlegungsgeschosse  
 Deformationsgeschosse  
 Vollmantelgeschosse  
 (für die Jagd verboten)



Ballistische Daten		Lauflänge 600 mm							Ball
Entfernung	(m)	0	50	100	150	200	250	300	Distanz
Geschwindigkeit	(m/s)	955	907	861	817	774	732	692	Velocität
Energie	(J)	3739	3373	3039	2737	2456	2197	1963	Energie
⊕ 100 m	(cm)		-1,0	⊕	-2,3	-8,3	-18,4	-33,0	⊕ 100 m
GEE* ⊕ 197 m	(cm)		1,0	4,0	3,7	-0,3	-8,4	-21,1	MRD*
*Günstigste Einschieß Entfernung									*Most

RWS®, RWS-Bullet-names or logos are registered trademarks of RUAG Ammotec GmbH  
 Unsere ballistischen Daten werden aus Prüfläufen ermittelt. Beim Verschießen der Munition



# Kaliberbezeichnung für Büchsen in Millimeter oder Zoll



1 Zoll oder inch = 2,54 cm

.30 Zoll (.308 WIN) :  $100 \times 2,54 \text{ cm} = 7,62 \text{ mm}$

.30/06 = 7,62 mm x 63 mm

.30 = Kaliber

06 = Einführungsjahr Patrone 1906

Metrische Kaliberbezeichnung 7x64 = Geschossdurchmesser 7mm,  
Hülsenlänge 64mm

Englische Kaliberbezeichnung 308 WIN = Nenndurchmesser: 7.62mm  
Geschossdurchmesser: 7,80mm

7x65R = Munition für Kipplaufwaffen R = Rand

MAG = Magnum, Bezeichnung für starke, amerikanische Kaliber

**Mindestkaliber 6,5mm  
257 WIN**



# Flintenmunition

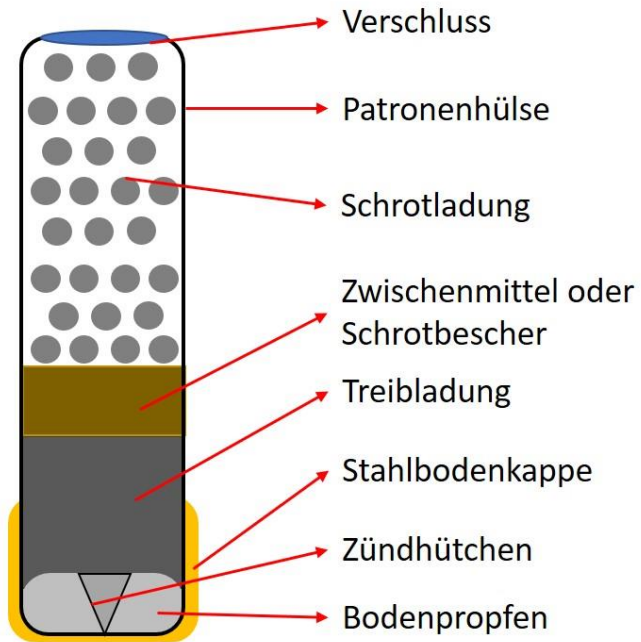

Blei- oder Stahlschrot für die Jagd auf Federwild

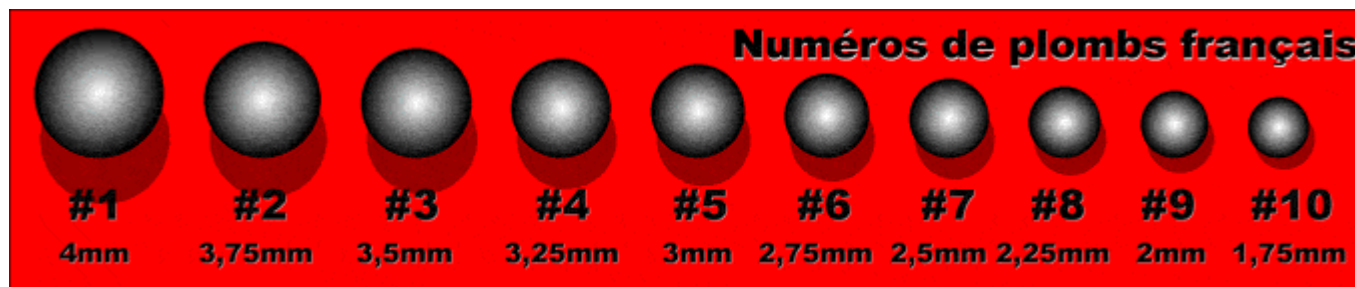

# Ballistik: Lehre über die Bewegung von Geschossen

Innenballistik:

Vorgänge im Innern des Laufes bei der Schussabgabe



Aussenballistik:

Geschossverhalten während des Flugs



Zielballistik:

Wirkung des Geschosses im Ziel



# Optik







Leichtes Fernglas für den Tag 8 x 30



Universalgläser 8-10 x 42



Dämmerungsgläser 8 x 56



Ferngläser mit integriertem  
Distanzmessgerät und  
Ballistikrechner



Genaueres Ansprechen auf grosse Distanzen.  
Nur aufgelegt oder mit Hilfe eines Stativs.



**Vergrößerungen :**  
**Bewegungsjagd** 1-4/24  
**Pirsch und Ansitz** 1,5-6/42  
 2,5-10/50  
**Nachtansitz** 3-12/56

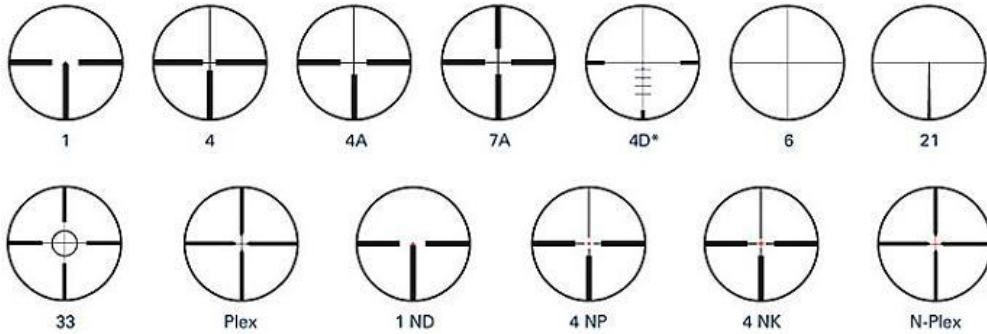

**4 = 70 cm auf 100 m**

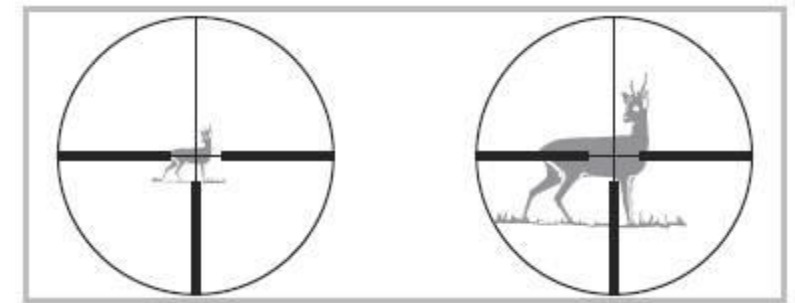

**3x**

**12x**

**4A = 140 cm auf 100 m**

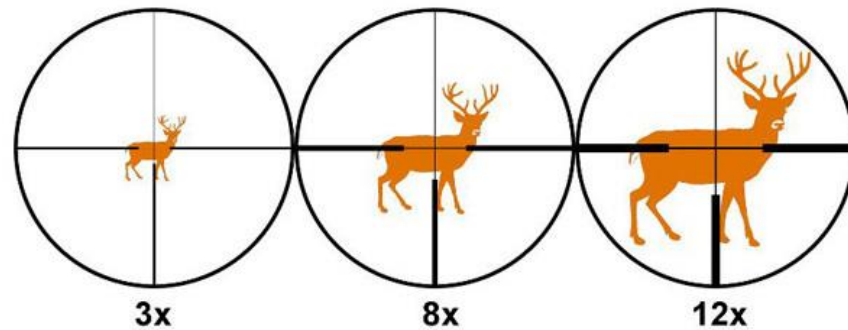

**3x**

**8x**

**12x**

Absehen 1. Bildebene =  
Vergrößerungswechsel  
verändert Zielbild und  
Absehen gleichzeitig

Absehen 2. Bildebene =  
Vergrößerungswechsel  
verändert nur das Zielbild

# Zielfernrohre der neuesten Generation



# Anschaffung Ausrüstung

Wesentliches	Leitfaden für den persönlichen Entscheid
<b>Flinte:</b> Doppel- oder Bockflinte, Kaliber 12-16-20	<b>Flinte:</b> Kaliber 12 Bockflinte mit Glasfaserkorn (Stil Truglo)
<b>Büchse:</b> Holz- oder Kunststoffschafft Drehkopf- oder Geradezug- oder Kipplaufverschluss Kaliber 6,5 - 7 - 7,5 - 7,6 - 8 - 8,5 - 9,3	<b>Büchse:</b> Kunststoff-, Holz-, oder Schichtholzschafft, Lochschafft mit ergonomischem Pistolengriff Kaliber 7x64, .308Win, .30-06Spr.
<b>Zielfernrohr:</b> 6x42 - 2,5-10x50 - 3-12x56 Leuchtabsehen	<b>Zielfernrohr:</b> 2-12x50, 3-12x56, 3-18x50 -Leuchtabsehen
<b>Munition:</b> Zerlegungsgeschosse – Deformationsgeschosse Kupfer - Blei – Zinn (Vollmantel 7,5x55 nur für Trainingsschiessen)	<b>Munition:</b> Teilmantel, z.B. Geco, S&B, Cineshot -günstige, präzise Übungsmunition
<b>Fernglas:</b> 8x42 – 10x42 – 8x56	<b>Fernglas:</b> 8x42, 10x42 mit Distanzmessgerät

**DIESES GEFÜHL, WENN**

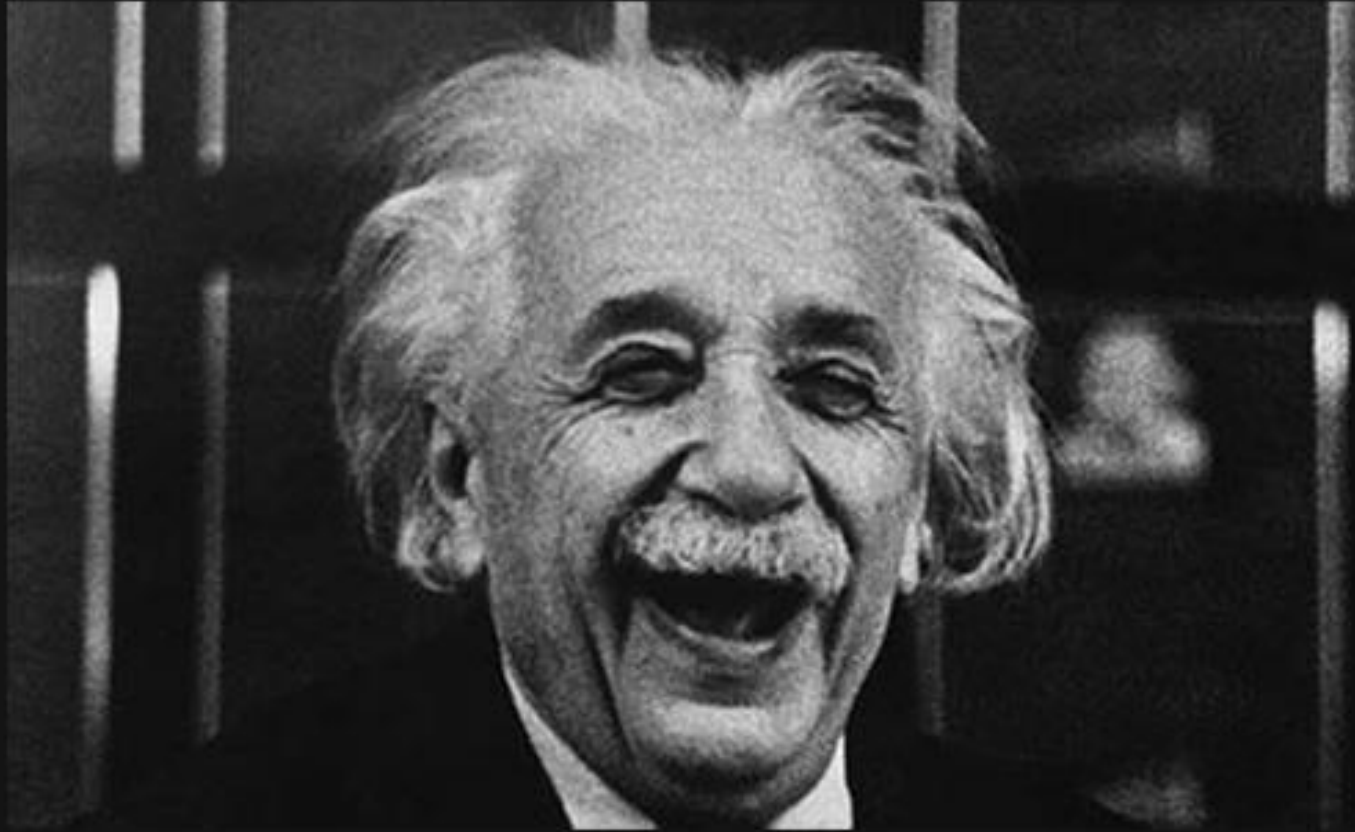

**MAN ALLES VERSTANDEN  
HAT**

